

PLUGGABLE SPDs FOR DIN RAIL MOUNTING

BXT ML4 BE 12

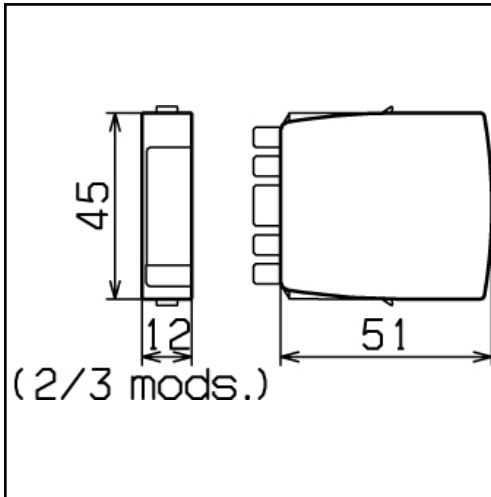

Dimension drawing BXT ML4 BE

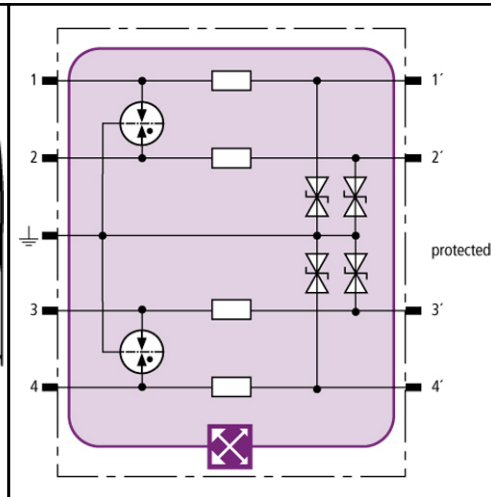

LifeCheck detects thermal and electrical overloads after which the SPD has to be replaced. Indication is performed by DEHNrecord LC without contacting.



- LifeCheck SPD control
- Optimum protection for 4 single lines
- For use according to the lightning protection zones concept at boundaries 0_A – 2 and higher

Space-saving combined lightning current and surge arrester module with LifeCheck for protection of 4 single lines with common reference potential as well as unbalanced interfaces.

BXT ML4 BE 12	
SPD Class	TYPE 1P1
SPD control	LifeCheck
Nominal voltage [U _N]	12 V
Max. continuous dc voltage [U _C]	15 V
Max. continuous ac voltage [U _C]	10.6 V
Nominal current at 45°C [I _L]	0.75 A
D1 Total lightning impulse current (10/350 μs) [I _{imp}]	10 kA
D1 Lightning impulse current (10/350 μs) per line [I _{imp}]	2.5 kA
C2 Total nominal discharge current (8/20 μs) [I _n]	20 kA
Voltage protection level line-line at I _{imp} D1 [U _p]	≤ 50 V
Voltage protection level line-PG at I _{imp} D1 [U _p]	≤ 30 V
Voltage protection level line-line at 1 kV/μs C3 [U _p]	≤ 38 V
Voltage protection level line-PG at 1 kV/μs C3 [U _p]	≤ 19 V
Series impedance per line	1.8 Ohm
Bandwidth Ad-PG [f _G]	2.7 MHz
Capacitance line-line [C]	≤ 0.9 nF
Capacitance line-PG [C]	≤ 1.8 nF
Operating temperature range	-40°C...+80°C
Degree of protection (plugged-in)	IP 20
Pluggable into	base part
Earthing by	base part
Enclosure material	polyamide PA 6.6
Colour	yellow
Test standards	IEC 61643-21
Ordering information	
Type	BXT ML4 BE 12
Part No.	920 322
Packing unit	1pcs.

Change in form and technology, with masses, weights and materials we reserve ourselves in the sense of the progress of the technology. The illustrations are noncommittal.