

SPDS TYPE 2

DG MOD 440

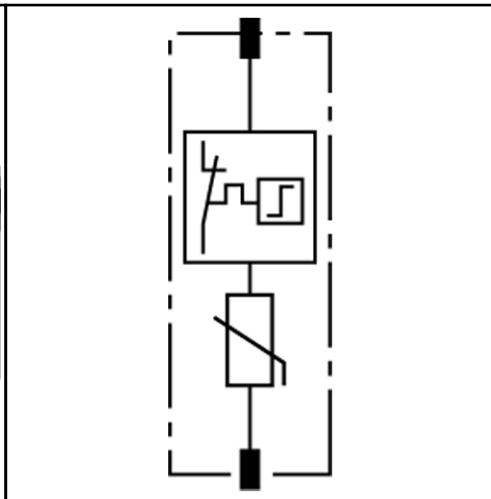
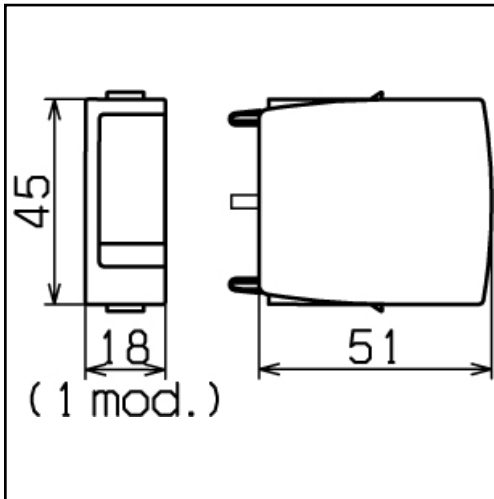

Dimension drawing DG MOD varistor-based protection module

Basic circuit diagram DG MOD varistor-based protection module

DG MOD ...: Varistor-based protection module for DEHNgard M ... and DEHNgard S ... surge arresters

- High discharge capacity due to powerful zinc oxide varistors/spark gaps
- High reliability due to "Thermo Dynamic Control"
- Energy-coordinated within the Red/Line product family
- Operating state/fault indication by mark in the inspection window
- Allows for easy module exchange without tools by module locking system with releasing button
- Tested for vibration- and shock-proofness acc. to EN 60668-2

DG MOD 440	
Nominal discharge current (8/20 µs) [I _n]	20 kA
Max. discharge current (8/20 µs) [I _{max}]	40 kA
Max. continuous ac voltage [U _C]	440 V
Max. continuous dc voltage [U _C]	585 V
Ordering information	
Type	DG MOD 440
Part No.	952 015
Packing unit	1 pcs.

Change in form and technology, with masses, weights and materials we reserve ourselves in the sense of the progress of the technology. The illustrations are noncommittal.